

PAR56 ECOPROOF LED LAMP FOR SWIMMING POOL – COLOR LIGHTING



Model : **502679**
 Type : 90 LED 3528 / 120°
 Color : 30R, 30G, 30B
 Control : On/Off and 433Mhz radio remote
 Functions : 11 static colors et 5 programs
 Material: lens, cup and nut in Polycarbonate (PC). Gland in nylon (PA)
 Wire connection : 2 screw terminals
 HS code : 9405403990
 Bar code : 3700450502679



Contents of the packaging :

- PAR56 EcoProof LED Lamp
- 3 screws M4x6 (#501580)
- 3 gaskets Ø7, Ø9 and Ø13mm (#501849)
- 4 polycarbonate wedges (PC) (#501887)
- 4 nylon screws (PA) (#501894)
- Radio remote (#502686)
- 1 CR2032 battery (#501832)
- Usage and maintenance manual



DIMENSIONS

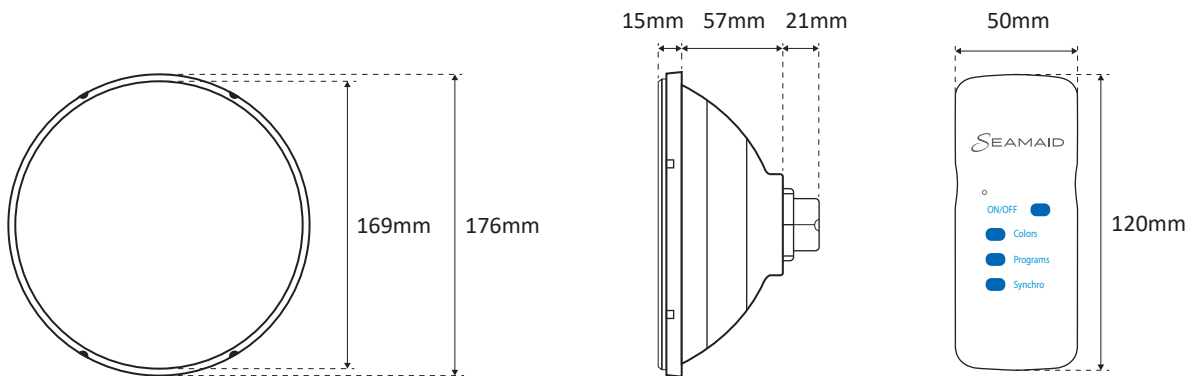

PACKING

Part Number	Box	Weight	Size	Carton	Weight	Size	Pallet	Weight	Size
502679	1U	0,71kg	17x17x17cm	6U	4,8kg	53x36x18cm	360U	307kg	100x120x205cm

CONNECTION

Use a 2 x 1mm² minimum cross section of connecting cable, to adapt according to the distance between the junction box of the projector and the transformer well as the power input.

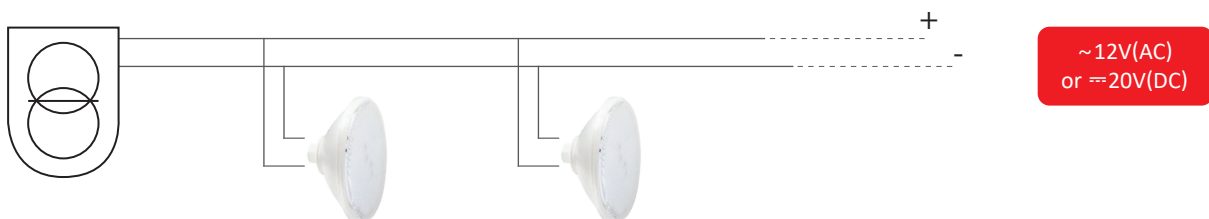

USE ONLY WITH A SAFETY TRANSFORMER / DO NOT PLUG IN SERIES /
 PROTECT THE CONNECTOR WITH INSULATING GEL

PHOTOMETRY

(Measurements performed in laboratory; * measurements made in water immersion)

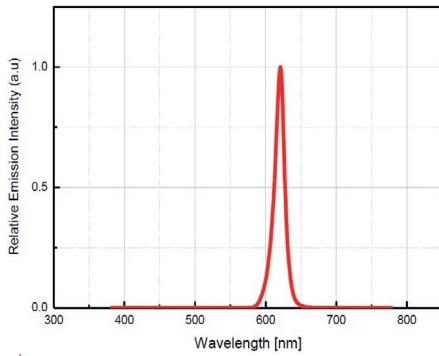

Wave length : 614/624nm
 Ra (IRC) : N/A
 Diffusion angle : 120°
 Nominal luminous flux : 112 lumens*

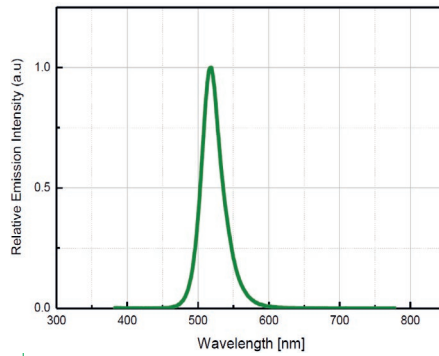

Wave length : 520/540nm
 Ra (IRC) : N/A
 Diffusion angle : 120°
 Nominal luminous flux : 320 lumens*

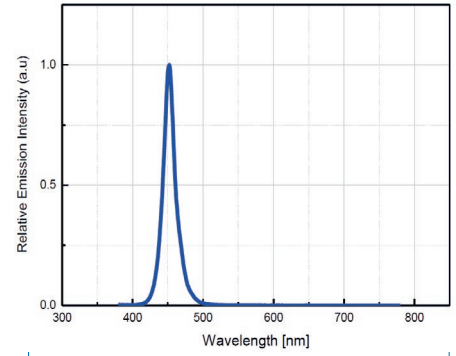

Wave length : 465/485nm
 Ra (IRC) : N/A
 Diffusion angle : 120°
 Nominal luminous flux : 80 lumens*

Maxi luminous flux : 512 lumens

ELECTRICAL PARAMETERS

Max instant power : 16W*
 Stabilized power >1h : N/A
 Power voltage : ~12V(AC) 50/60Hz or ~20V(DC)
 PF max : 0,7 si ~12V(AC)
 PF max : 1 si ~20V(DC)
 Mini power supply ~12V(AC) [(Pi /PF)+20%] : 28VA
 Electrical Class : III
 EEI : N/A

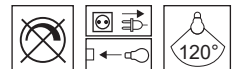

CLASS III III ~12V(AC)
 ~20V(DC)

OTHER PARAMETERS

Protection index : IP68*
 LED life span : 15 000h
 On/Off cycles : > 100 000
 Use : permanent under water use only

On/Off >100 000

USE ONLY IN OUTDOOR POOL LAMP NOT SUITABLE FOR ACCENT LIGHTING

Hg 00mg

IP68 1,0m

CERTIFICATION

EMC 2014/30/EU Directive.
 Radio RED 2014/53/EU Directive.
 EN60598-1 / EN60598-2-18 Norm in all its modifications.

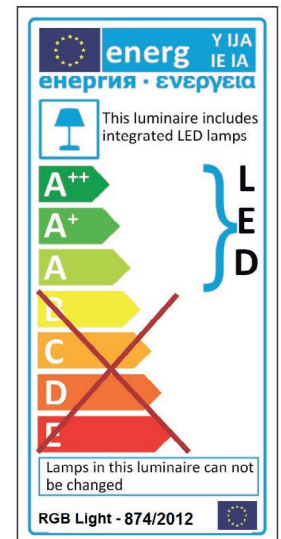

«SPECIAL USE LAMP, COLOR CHANGING MODE NOT CONCERNED BY 1194/2012 PERFORMANCE»